

Customer Care Solutions

RH-4 Series Cellular Phones

8 – Accessories

Table of Contents

Description	Page No.
Accessories	3
BL-4C, E&A, APAC = Battery, Americas = Li-Ion Battery	3
ACP-7, E&A, APAC = Standard Charger, Americas = Standard Travel Charger	4
ACP-8, E&A = Travel Charger, APAC = Fast & Light Charger	5
ACP-12, Travel Charger	6
LCH-9, Mobile Charger	7
LCH-12, Mobile Charger	8
HS-5, Headset	8
HDB-4, Boom Headset	9
HS-10, Retractable Headset	9
LPS-4, Inductive Loopset	10
HS-1C, Camera Headset	11
HS-2R, FM Radio Headset	12
BHF-1, Headrest Handsfree	12
DKU-5, Connectivity Adapter Cable	13

Accessories

BL-5C, (E&A, APAC = Battery, Americas = Li-Ion Battery)

Product details

Features

- Thin and light weight battery

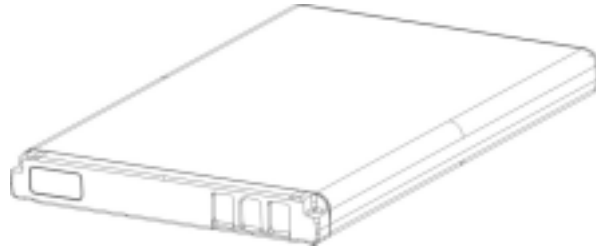

Specifications:

Bulk Codes:	Eur/Afr & APAC type label	0670386
	France type label	0670387
	China type label	0670389
	Americas type label	0670388
Outbox Codes:	Eur/Afr	0273560
	France	0273561
	APAC	027xxxx
	Americas	027xxxx
Capacity:		720 mAh
Weight:		18.5 g
Length:		53 mm
Width:		34 mm
Thickness (nominal):		4.6 mm
Thickness (max):		5.0 mm
Nominal voltage:		3.7 V
Operating temperature:		- 10°C to + 40°C
Recommended temperature usage range:		+ 15°C to + 25°C
Contact interface:		3 pins golded (Lynx)
Color:		Top caps black
		Foil color open

**ACP-7, (Eur/Afr & APAC = Standard Charger)
(Americas = Standard Travel Charger)**

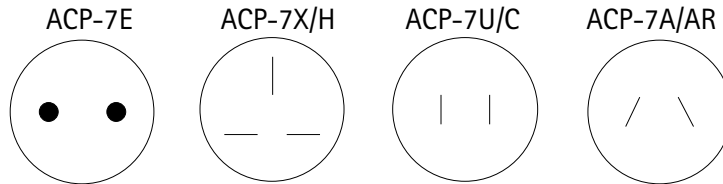
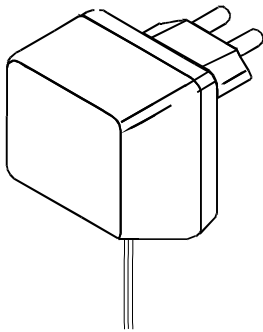

Product details:

Features:

- easy and convenient way to charge the phone
- small, lightweight and durable
- easy to connect to phone or desktop stand

Specifications:

Product code, ACP-7U (Made in country):	0675143
Product code, ACP-7U (Made by "manufacturer"):	0675172
Product code, ACP-7E (Made in country):	0675144
Product code, ACP-7E (Made by "manufacturer"):	0675171
Product code, ACP-7X (Made in country):	0675145
Product code, ACP-7X (Made by "manufacturer"):	0675173
Product code, ACP-7H:	0675146
Product code, ACP-7C:	0675212
Product code, ACP-7C (Philippines ONLY):	0675158
Product code, ACP-7A:	0675148
Product code, ACP-7AR:	0675244
Dimensions (H x W x D):	38 x 47 x 53 mm
Weight:	187 g
Length of cable:	2000 mm ± 10%
Input voltage: ACP-7U (US):	120 V AC, 60 Hz
ACP-7E (Europe) and ACP-7X (UK):	230 V AC, 50 Hz
ACP-7A (Australia):	240 V AC, 50 Hz
ACP-7C (China):	220 V AC, 50 Hz
ACP-7H (Hong Kong):	200 V AC, 50 Hz
ACP-7AR (Argentina):	220 V AC, 50 Hz
Output voltage:	7.6 ± 0.35 V
Charging time:	Refer to battery specifications

**ACP-8, (Eur/Afr = Travel Charger)
 (APAC = Fast & Light Charger)
 (Americas = Rapid Travel)**

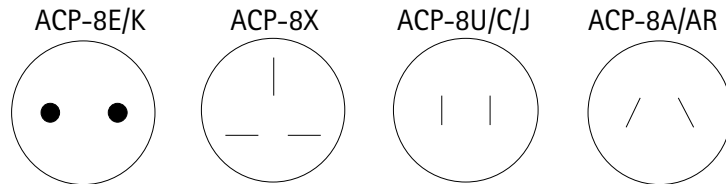
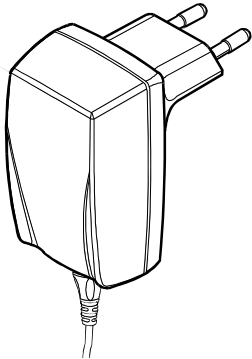

Product details:

USPs:

- beautiful Nokia design
- talk and charge at the same time
- Nokia power management – phone, battery and charger all working together for the best results
- fast and efficient way to charge the phone battery
- multivoltage
- small, lightweight and durable
- easy to connect to phone or desktop stand
- cable management provided with velcro strap
- suitable for active travellers

Specifications:

Product code, ACP-8E:	0675195
Product code, ACP-8U:	0675196
Product code, ACP-8U (Made by "manufacturer"):	0675269
Product code, ACP-8X:	0675197
Product code, ACP-8J:	0675198
Product code, ACP-8K:	0675199
Product code, ACP-8A:	0675214
Product code, ACP-8C:	0675211
Product code, ACP-8UB:	0675236
Product code, ACP-8G:	0675237
Product code, ACP-8AR:	0675248

Dimensions, ACP-8E/K (H x W x D):	70 x 40 x 73 mm
Dimensions, ACP-8U/C/G/UB (H x W x D):	70 x 40 x 56 mm
Dimensions, ACP-8X (H x W x D):	72 x 50 x 64 mm
Dimensions, ACP-8A/AR (H x W x D):	74 x 43 x 61 mm
Weight:	75 + 35 (cable) g
Length of cable:	1800 mm ± 50 mm
Color:	Warm Black
Input voltage:	90 to 264 V AC, 50/60 Hz
Output voltage:	6.0 +0.3 V / -0.7 V
Charging times:	Refer to battery specifications
Operating temperature:	- 5° ... + 45° C

ACP-12, Travel Charger

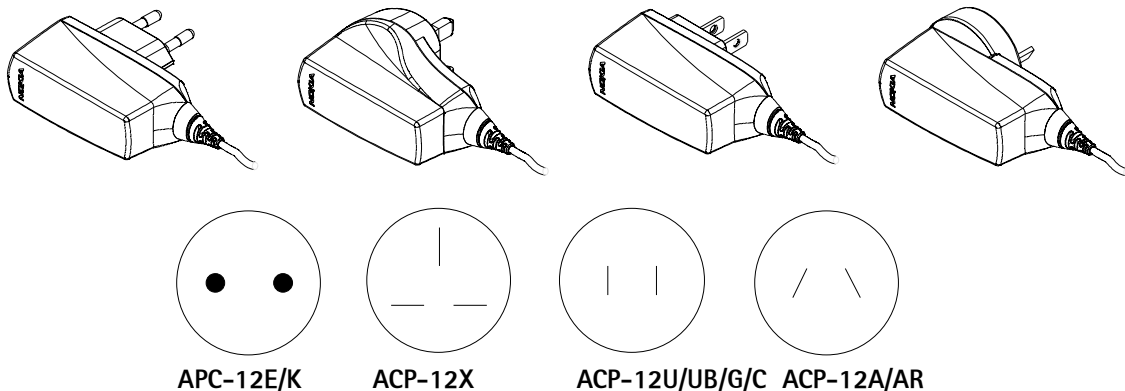

Product details:

Features:

- Small and light weight travel charger
- High performance charger
- Multivoltage (90 -264V)
- Fullfills the long run EU Code of conduct requirement on efficiency
Low standby power consumption < 300mW
- Fixed cable with cable management

Specifications:

Product code, ACP-12E:	0675294
Product code, ACP-12X:	0675296
Product code, ACP-12U:	0675303
Product code, ACP-12UB:	0675293
Product code, ACP-12G:	0675295
Product code, ACP-12C:	0675297
Product code, ACP-12A:	0675300
Product code, ACP-12AR:	0675298

Dimensions (H x W x D):	28x75x70mm (E), 50x75x60 (X)
Weight:	~ 85g
Length of cable:	1800mm +/-50mm
Colour:	Warm black
Cable Management:	Velcro type
Input voltage:	90 - 264V AC 50/60Hz
Output voltage	5,7VDC, 800mA
Standby power consumption:	<300mW
Operating temperature:	- 25° ... + 55° C

LCH-9, Mobile Charger (Americas = Rapid Cigarette Lighter Charger)

Product details:

Features:

- easy and convenient way to charge the phone battery in a vehicle
- suitable for most vehicle's cigarette lighter socket
- a green light indicates readiness for charging
- light weight and small size - unobtrusive when plugged into the cigarette lighter socket wherever the socket is located
- easy to connect the DC cable/connector to the phone
- can be used with 12 V or 24 V systems

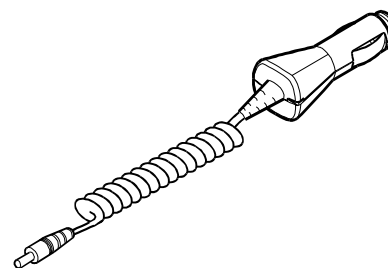

Specifications:

Product code (English type label):	0675120
Product code (Chinese type label):	0675239
Dimensions (H x W x D):	29 x 35 x 94 mm
Weight:	97 g
Length of cable:	Coiled 0.3 m ± 10% (Uncoiled 3 m ± 10%)
Input voltage:	10.8 to 32 V DC
Output voltage:	7.8 ± 1 V
Charging time:	Refer to battery specifications

LCH-12, Mobile Charger

Product details:

Features:

- High performance charger
- Easy and convenient way to charge the phone battery in a vehicle
- A green light indicates readiness for charging
- Can be used with 12 VDC or 24 VDC systems
- Light weight and small size - unobtrusive when plugged into the cigarette lighter socket wherever the socket is located

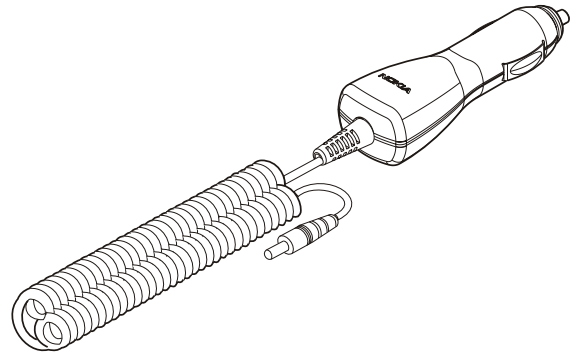

Specifications:

Product code LCH-12:	0675328
Dimensions (H x W x D):	26 x 34 x 98 mm TBD
Weight:	< 100 g
Length of cable:	Uncoiled 160 cm \pm 10% (Coiled TBD cm \pm 10%)
Input voltage:	10.8 to 32 V DC
Color	Jet Black
Nominal output voltage, current:	5.7 VDC, 800mA
Operating temperature:	-25°C ... +55°C (normal temperature range in which the charger must fulfill all the specifications)

HS-5, Headset

Product details:

USPs/Features:

- Basic headset with good audio quality
- Send/End button for convenient usage
- Low cost



Specifications:

Product code (Eur/Afr and APAC type label):	0694120, 0694121 & 0694122
Dimensions (H x W x D):	72 x 48 x 17mm
Weight:	20 g
Length of cable:	1350 +/- 30 mm (Earpiece to Connector)
Connector Type:	Pop-Port
Earpiece Size:	16.5mm (max. speaker capsule diameter)
Colour:	Black
Operating temperature:	- 25° ... + 55° C

HDB-4, Boom Headset

Product details:

USPs:

- basic HF functionality with send/end button
- new concept
- beautiful and distinctive Nokia design
- small and lightweight
- excellent audio quality

Features:

- basic HF functionality with send/end button
- new concept
- Microphone and speaker integrated to the boom

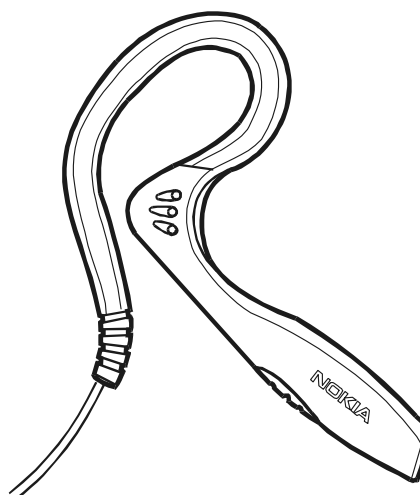

Specifications:

Product code:	0694094
Product code (Chinese label):	0694108
Color:	Black
Weight:	20g
Length of cable:	970 +/- 25 mm
Connector:	Tomahawk
Operating temperature:	-20° C ... + 60° C

HS-10, Retractable Headset

Product details:

USPs:

- Retractable mechanism for cable management
- Microphone and speaker integrated into the earpiece
- Send/End button for call handling
- Hook in the unit for carrying the device

Features:

- Send/End
- Retractable mechanism for cable management
- Hook for carrying the device on the belt e.g.



Specifications:

Product code (Eur/Afr and APAC type label):	0694114
Dimensions (H x W x D):	72 x 48 x 17mm
Weight:	30 g
Length of cable:	1000 +/- 30 mm (Earpiece/mic to reel unit) 150 +/- 10 mm (Reel unit to phone)
Connector:	Pop-Port
Colour:	
Operating temperature:	- 25° ... + 55° C

LPS-4, Inductive Loopset**Product details:****USPs:**

- Mobile freedom for hearing aid users
- Handsfree operation without batteries

Features:

- No batteries needed
- ACI = Loopset detection
- Cochlear Implant connector support
- Excellent audio quality
- Audio input (connection to external devices e.g. tv, video etc.)

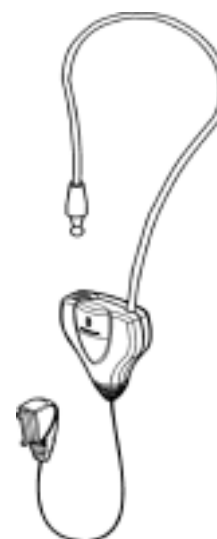
**Specifications:**

Product code (Eur/Afr and APAC type label):	0630443
Product code (Chinese type label):	06XXXXX ?
Product code (Americas type label):	06XXXXX ?
Dimensions (H x W x D):	17 x 40 x 55 mm
Weight:	48 g
Length of cable:	mm ?
Color:	dark platinum 2
Charging times:	No batteries needed
Operating temperature:	- 20° ... + 55° C

HS-1C, Camera Headset

Product details:

USPs:

- Combination of digital Camera and Headset
- Basic Handsfree functionality with answer/end button
- Small and lightweight
- Stylish and trendy Nokia design
- Excellent wearability

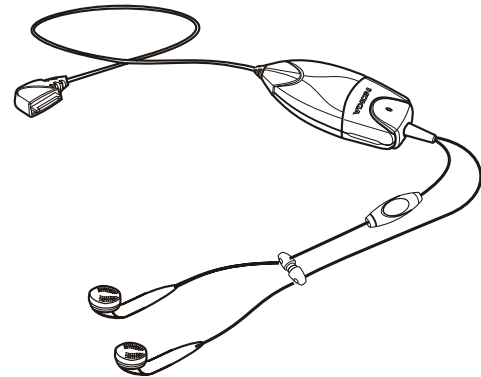

Features:

- Single shot camera – VGA and low resolution selection
- Pop Port connection – power from phone
- LED for indicating operating mode of the camera
- Optical viewfinder
- Photos are displayed on phone display
- Store, delete, send etc. commands from the phone
- Dual mono headset
- Answer/end button in headset part
- Microphone integrated into the camera unit

Specifications:

Product code (Eur/Afr and APAC type label):	0694XXX
Product code (Chinese label)	0694XXX
Weight:	XX g
Dimension:	XX
Length of cable:	XX mm
Color:	Light champagne
Connector:	Pop Port
Resolution:	VGA 640x480 Low resolution 128x96
Color depth:	24 bit
Light sensitivity:	10 Lux
Operating temperature:	XX

HS-2R, FM Radio Headset

Product details:

USPs:

- Combination of Stereo FM Radio and Headset
- Excellent audio quality
- Basic Handsfree functionality with answer/end button
- Small and lightweight
- Stylish and trendy Nokia design

Features:

- Stereo FM Radio
- Display for showing played radio station
- Radio channel seek, volume adjustment, power on/off and key lock buttons
- Pop Port connection – power from phone
- Mono headset
- Answer/end button in headset part
- Automatic switch between radio and headset

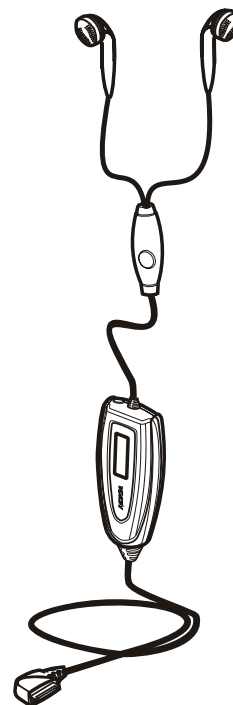

Specifications:

Product code (Eur/Afr and APAC type label):	0694XXX
Product code (Chinese label)	0694XXX
Weight:	XX g
Dimension:	XX
Length of cable:	XX mm
Color:	Light black
Connector:	Pop Port
Operating temperature:	XX

BHF-1 Headrest Handsfree

Product details:

USPs:

- Excellent audio quality
- Easy to install
- Basic handsfree functionalities
- Easy to use
- Ergonomic and distinctive Nokia design



Features:

- Integrated microphone and speaker
- Installation in car's headrest
- Safe handsfree functionality in car environment

Specifications:

Product code (Eur/Afr and APAC type label):	0694102
Dimensions (L x W x H):	250mm x 40mm x 40mm (main body), 15mm x 200mm (flexible arm)
Weight:	300 g
Length of cable:	3 m
Colour:	Black, Palladium (silver)
Operating temperature:	- 25° C ... + 55° C

DKU-5 Connectivity Adapter Cable

Product details:

USPs:

- Seamless connectivity between USB compatible PC and Nokia phone. Supports Nokia PC Suite usage and synchronization desk stand.
- Enables data transfer and synchronization with PC (calendar, phone book, notes, to do list, etc. depending on PC Suite features)
- Fast data rate 230kbits/s supported



Features:

- FBUS/USB adapter cable for phone without USB support
- USB connectivity to PC
- Supporting fast data rate up to 230kbits/s (Fast FBUS data rate 230kbits/s supported - 115.2kbits/s default on phone side)
- Accessory identification – ACI function

Specifications:

Product code:	0730235
Sales package code (Eur/Afr):	0273436
Type Label Size:	13x10 mm (USB)
Weight:	44 g
Length of cable:	1200 mm
Colour:	Black
Material:	Halogen free PVC
Operating temperature:	- 35° ... + 80° C

This page intentionally left blank